



GST301

Extinguishing Control Panel

Installation and Operation Manual

Issue 3.03 April 2013
ERP:30306981

CONTENTS

I	General	1
II	Features	1
III	Technical Specifications	1
IV	Structure and Operation Principle.....	1
V	Mounting and Commission	7
VI	Operation	12
VII	Troubleshooting	15
VIII	Cautions	15

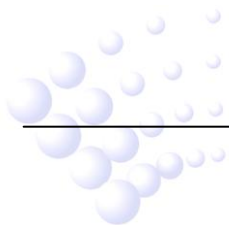

I General

GST301 Extinguishing Control Panel (hereinafter called the panel) is a stand-alone panel intended for use with gas extinguishing systems. The function of the panel is to monitor zones or areas for fire conditions and give an appropriate audible/visible indication. The panel also provides a facility for initiating the gas release to put out fire, both manually and automatically.

II Features

GST301 Extinguishing Control Panel has 2 detection zones to achieve double-knock function, and a normal detection zone for extra usage. With C-9317 Emergency Gas Override Control (emergency start/abort button), gas release can be controlled in field.

III Technical Specifications

- 1 Operating Voltage: 220/230VAC,50/60Hz
- 2 Power Consumption \leq 20W (Monitoring Mode)
- 3 Battery Requirement: 2X12VDC, 7Ah
- 4 Battery Operating Time:
 - a) 24 hours monitoring and half an hour alarm if the current of AUX power output is 0mA.
 - b) 8 hours monitoring and half an hour alarm if the current of AUX power output is 100mA.
- 5 AUX Power Supply:100mA/24VDC
- 6 Sounder Output: 0.5A/24VDC
- 7 Release Output: 2A/24VDC, pulse
- 8 Battery Charge Current: 300mA
- 9 Maximum Detectors in Each Zone: 15
- 10 Maximum Number of C-9317 Emergency Gas Override Control: 4
- 11 Operating Environment:
 - Temperature: 0°C~40°C
 - Relative Humidity: \leq 95%, non condensing
- 12 Dimension: 300mmX350mmX110mm
- 13 Mounting Hole Distance: 260mm

IV Structure and Operation Principle

- 1 The panel is wall-mounted. It mainly consists of a cabinet, a main board, a display board, and a transformer. Its structure is shown in Fig. 1.

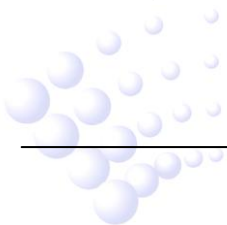

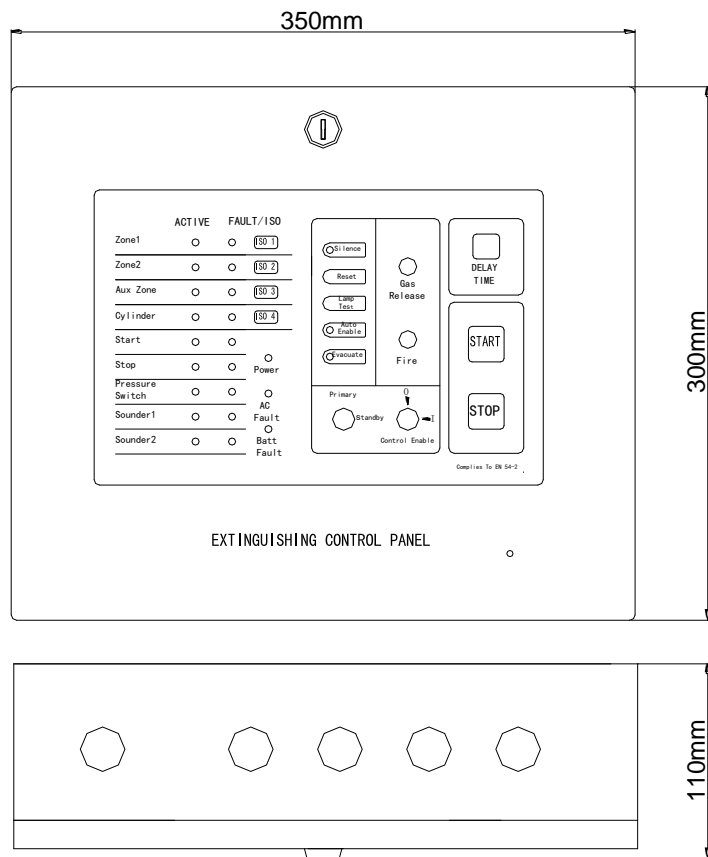

Fig. 1 Appearance

2 Front panel

1) Front panel of GST301 is shown in Fig. 2.

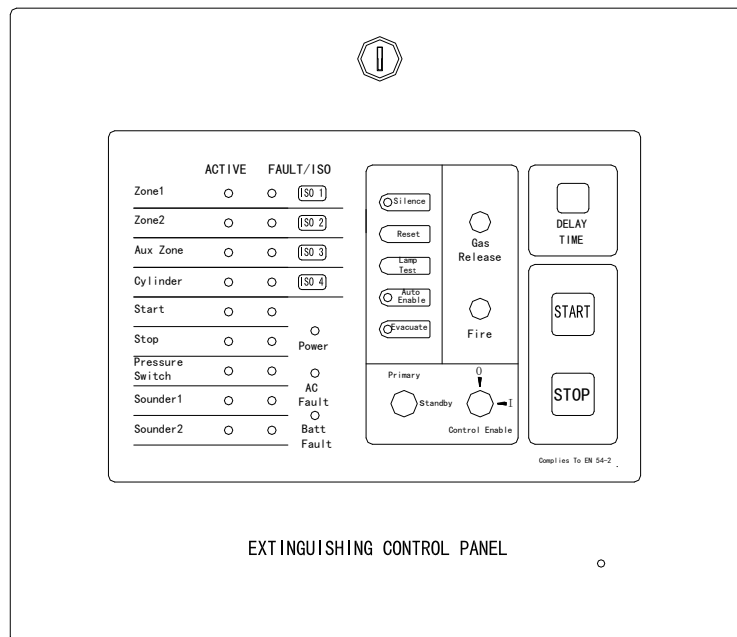

Fig. 2 Front panel

2) Indicators

- Power Green. Lighted when power supplied.
- AC Fault Amber. Lighted when there is AC Fault.
- Batt Fault Amber. Lighted when battery voltage is below 5V.
- Gas Release Red. Flashes during delay time. Lighted after gas released. Extinguished by reset.

- Fire Red. General fire indication. Lighted by any fire signal. Extinguished by reset.

- Silence Green. Lighted if the panel is silenced. Extinguished when it re-sounds.

- Auto Enable Green. Lighted if the panel is in automatic mode. Off for manual only mode.

- Evacuate Green. Flashes when “Evacuate” key is pressed. Extinguished by reset.

- DELAY TIME Red. Indicating the time (in second) before gas releasing.
- Zone1 ACTIVE Red. Flashes when Zone1 is in alarm. Lighted steadily after it’s silenced. Extinguished by reset.

- Zone1 Fault/ISO Amber. Flashes when Zone1 has any fault. Off when the fault is removed. Steadily lighted when Zone1 is isolated.

- Zone2 ACTIVE Red. Flashes when Zone2 is in alarm. Lighted steadily after it’s silenced. Extinguished by reset.

- Zone2 Fault/ISO Amber. Flashes when Zone2 has any fault. Off when the fault is removed. Steadily lighted when Zone2 isolated.

- Aux Zone ACTIVE Red. Flashes when the AUX Zone is in alarm. Lighted steadily after it’s silenced. Extinguished by reset.

- Aux Zone Fault/ISO Amber. Flashes when the AUX zone has any fault. Steadily lighted when the AUX zone is isolated. OFF when the fault is removed.

- Cylinder ACTIVE Green. Flashes when the release output is active. Extinguished after output finished.

- Cylinder FAULT/ISO Amber. Flashes when the gas release output circuit has any fault. Lighted steadily in isolated mode.

- Start ACTIVE Green. Flashes when the “START” key on the panel or the Emergency Start Button in field is pressed.

- Start FAULT Amber. Lighted by fault with Emergency Start Button Circuit. Extinguished when fault removed.

- Stop ACTIVE Green. Flashes when the “STOP” key on panel or the field Emergency Abort Button is pressed.

- Stop FAULT Amber. Lighted by fault with Emergency Abort Button Circuit. Extinguished when fault removed.

- Pressure Switch ACTIVE Green. Lighted if the pressure switch is active (gas released) or after gas release output started (no pressure switch). Extinguished by reset.

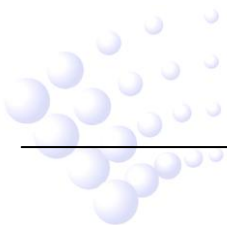

- Pressure Switch FAULT Amber. Lighted by fault with pressure switch circuit. Extinguished when the fault is removed.
 - Sounder 1 ACTIVE Green. Lighted when sounder 1 output is started. Extinguished when sounder 1 output is stopped.
 - Sounder1 FAULT Amber. Lighted by fault with sounder 1 Circuit. Extinguished when the fault is removed.
 - Sounder2 ACTIVE Green. Lighted when sounder 2 output is started. Extinguished when sounder 2 output is stopped.
 - Sounder2 FAULT Amber. Lighted by fault with sounder 2 Circuit. Extinguished when the fault is removed.
- 3) Keys & Switches
- Silence Stop all sounder outputs and local alarm (panel buzzer will beep at 0.5s ON & 9.5s OFF mode). Sounder outputs will be resumed by new active events (fire/start/pressure switch action) or new fault signal or by pressing “Evacuate” key. If delay timer is running, local alarm will not be stopped, and sounder outputs will be resumed within the last 15 seconds.
 - Reset Clear all inputs, indications and outputs.
 - Lamp Test Check indicators and the buzzer.
 - Auto Enable Enable the automatic gas release function by fire alarm of two detectors. If this function is not enabled, the gas release will not be started even if fire is detected by detectors.
 - Evacuate Start the two sounder outputs. Stop by reset.
 - Control Enable Manual control authorization. In disable mode (position “0”), only “Lamp Test” and “STOP” keys can be operated. In enable mode (position “1”), all keys can be operated.
 - Primary/Standby Switch gas release output between primary and standby.
 - START Manual release control button.
 - STOP Stop delay timer (keeping remained time shown). Stop Sounder2 output. Inhibit automatic gas release output .
 - ISO1~ISO4 Logically isolate corresponding terminals. Available for Zone1, Zone2, AUX Zone and Cylinder. But “ISO4” is only functioning for automatic gas release. The cylinder can still be discharged manually even if it is isolated.

Sound indication: Alarm sound is provided by 70dB~100dB buzzer.

3 Internal Structure

- 1) Internal structure of the panel is shown in Fig. 3.

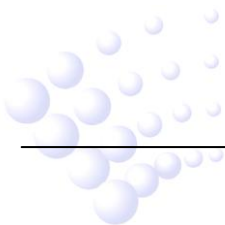

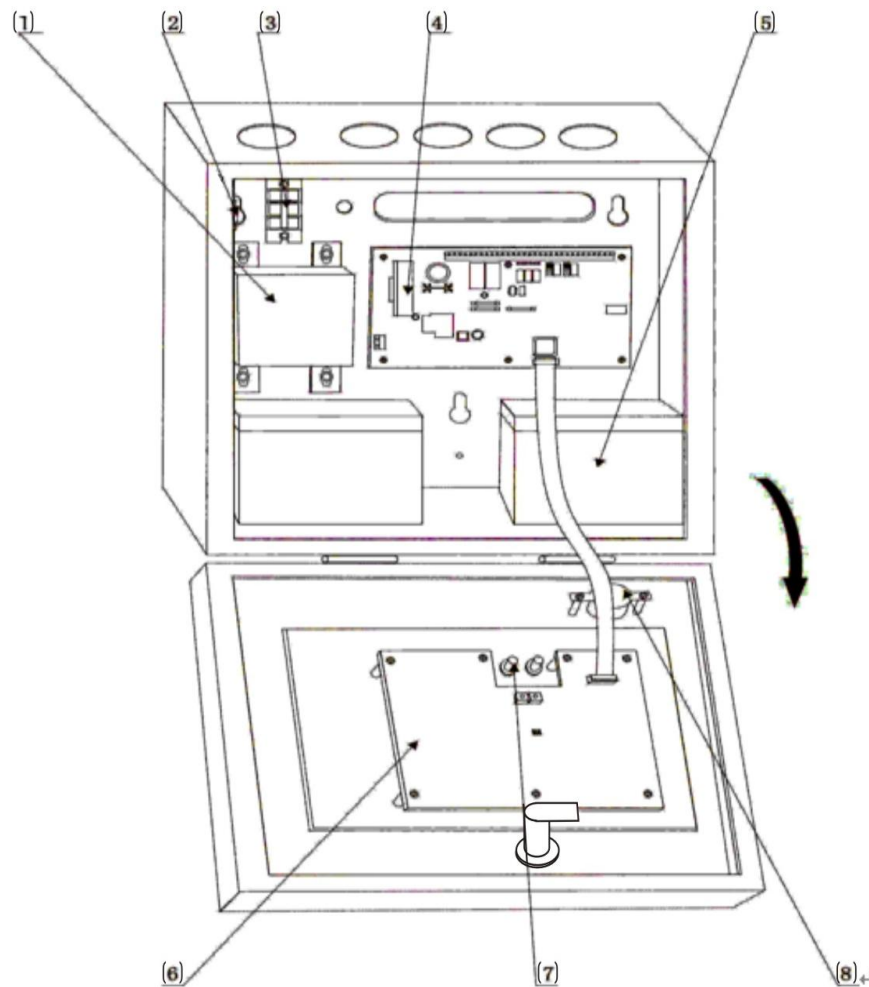
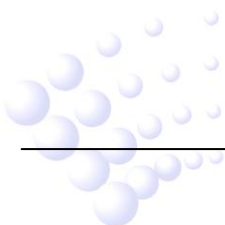

Fig. 3 Internal structure

- (1) AC transformer: 220/230VAC input, 27VAC output.
 - (2) Input current fuse of the AC transformer: 1A
 - (3) AC Input: 220/230VAC input
 - (4) Main board
 - (5) Battery: 12VDC 7Ah each
 - (6) Display board
 - (7) The cylinder output selection switch and manual control enable switch
 - (8) Buzzer
- 2) Main Board



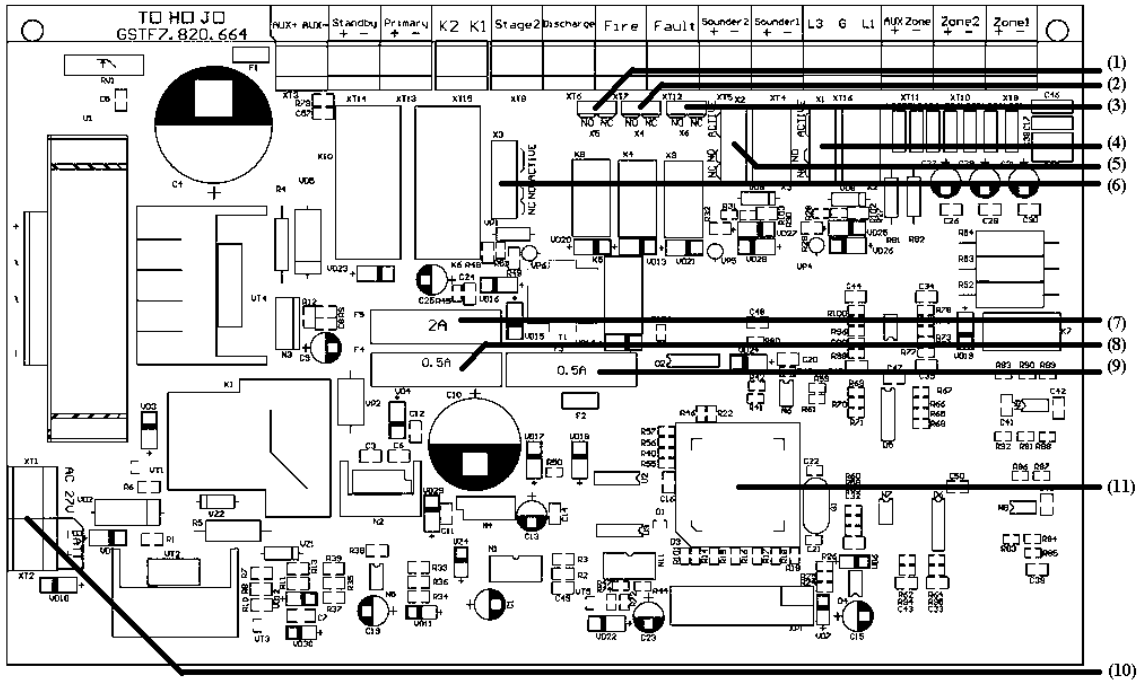

Fig. 4 Main board structure

- (1) X5: Discharge remote output mode setting (NO/NC)
 - (2) X4: Fire remote output mode setting (NO/NC)
 - (3) X6: Fault remote output mode setting (NO/NC)
 - (4) X1: Sounder1 output mode setting (Active/NO/NC)
 - (5) X2: Sounder2 output mode setting (Active/NO/NC)
 - (6) X3: Cylinder output mode setting (Active/NO/NC)
 - (7) F5: Fuse of cylinder output (active mode)
 - (8) F4: Fuse of Sounder2 output (active mode)
 - (9) F3: fuse of Sounder1 output (active mode)
 - (10) XT1, XT2: AC terminal and battery terminal
 - (11) D1: MCU
- 3) Display Board

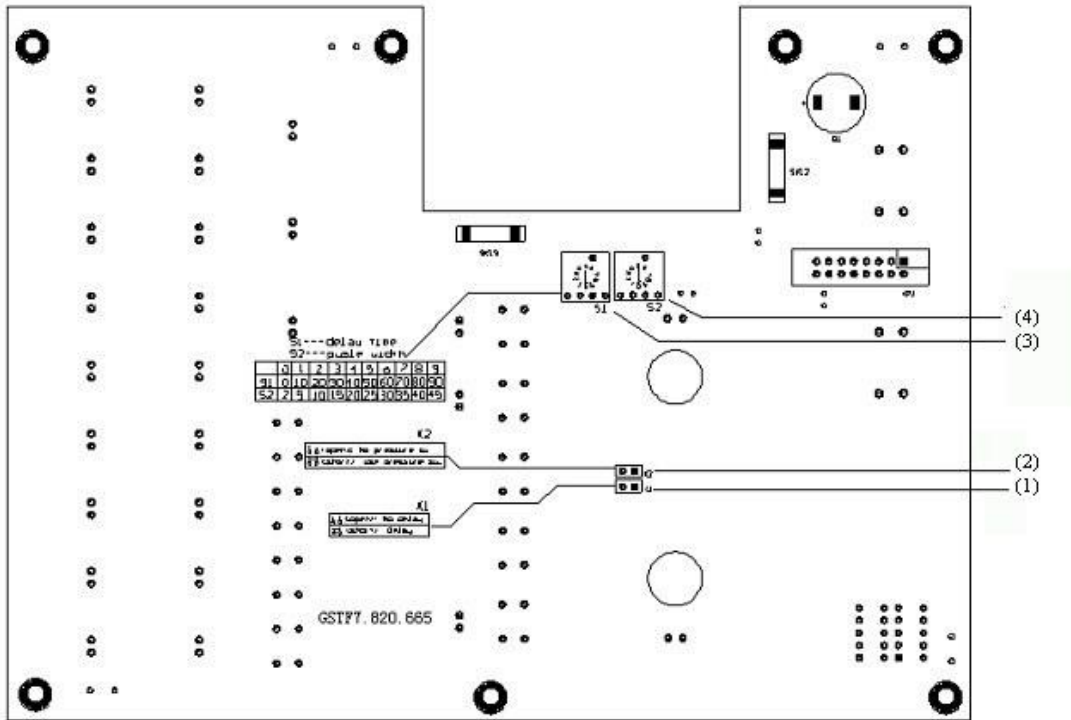

Fig. 5 Display board

- (1) X1: Emergency action mode setting by pin, with delay or without delay.
- (2) X2: Remote discharge remote output setting by pin, by pressure switch or output action.
- (3) S1: Code switch for delay time setting.
- (4) S2: Code switch for cylinder output pulse duration setting.

V Mounting and Commission

- 1 Check the configuration according to packing list. The main items are: Installation and Operation Manual and accessories, etc. Then check the appearance of the panel.
- 2 Check the inside configurations referring to Section 4 of this manual. Check the connection of all parts and make records for commissioning.
- 3 Mounting Method

The panel is wall-mounted. Mounting dimension (unit:mm)is shown in Fig. 6.

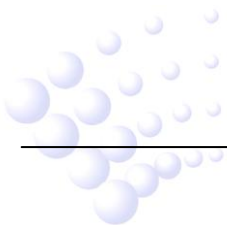

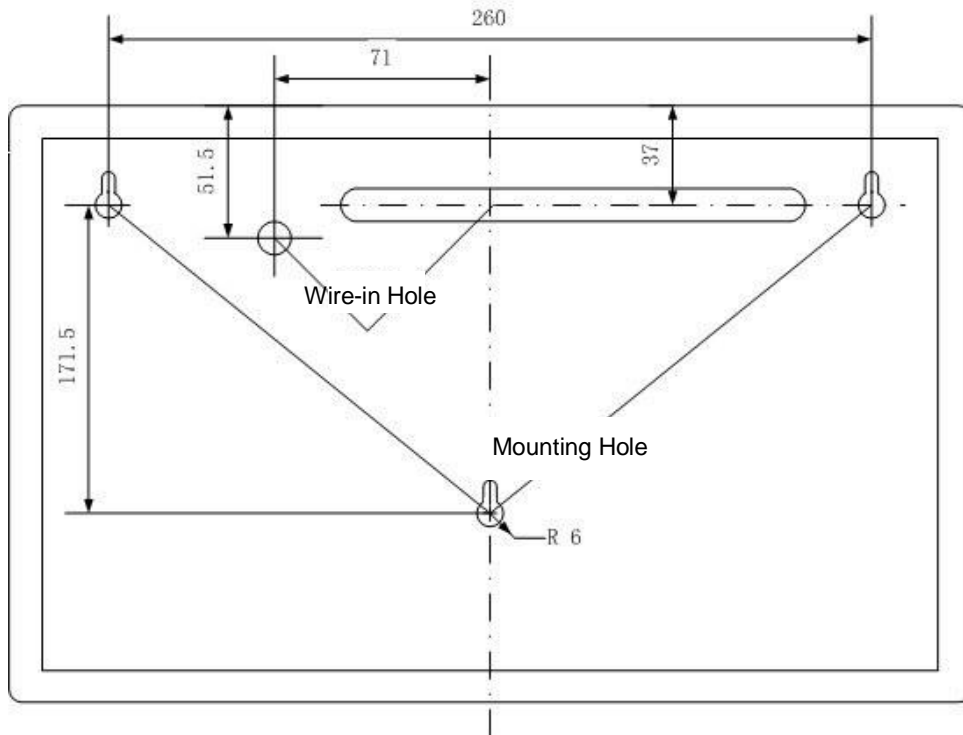

Fig. 6 Mounting

4 Terminals

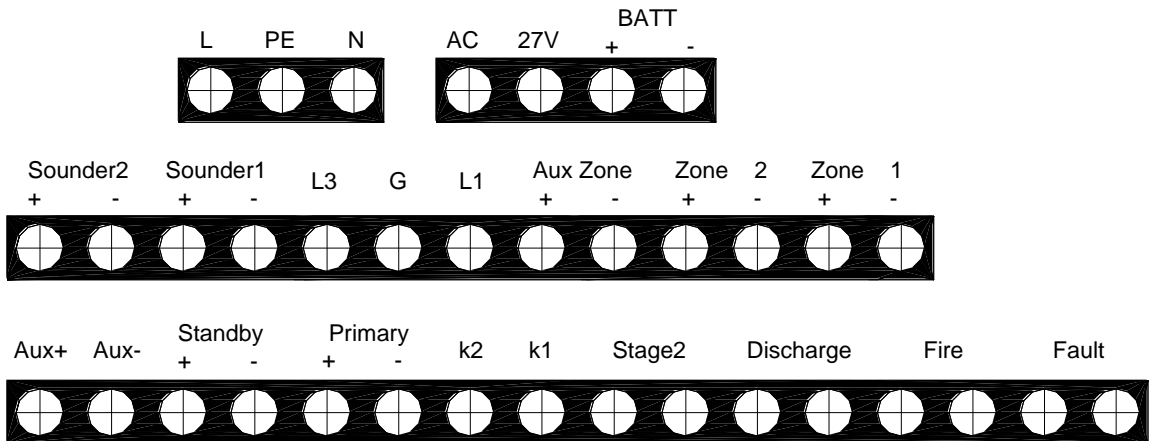

Fig. 7 Terminals

- (1) L, N: 220/230VAC input
- (2) PE: GND terminal
- (3) BATT+, -: Battery input connecting with internal or external battery.
- (4) AC, 27V: 27VAC input from transformer.
- (5) Sounder 2 +, - / Sounder 1 +, -: Sounder outputs connecting with Audio / Visual devices. 0.5A/24VDC active output, which can be set to NO/NC type.
- (6) L3, G, L1: Emergency start/abort terminal connecting with C-9317.
- (7) Aux Zone +, - / Zone 2 +, - / Zone 1 +, -: Zone inputs connecting with conventional detectors and manual call points.

- (8) Aux +, Aux -: Aux power supply (100mA/24VDC).
- (9) Standby +, - / Primary +, -: Gas release output connecting with primary and standby cylinder. 2A/24VDC active output can be set to NO/NC type. 2 to 45 seconds adjustable pulse output.
- (10) K2, K1: Pressure switch input connecting with cylinder pressure switch. Dry contact input.
- (11) Stage 2: Pre-release remote output. NO dry contact.
- (12) Discharge: Gas discharge remote indication output. NO/NC dry contact.
- (13) Fire: Fire remote indication output. NO/NC dry contact.
- (14) Fault: Fault remote indication output. NO/NC dry contact.

5 Wiring

1) Recommended cabling

- a) 227 IEC 02 fire cable with cross section not less than 1.5mm² for Zone, Sounder, Remote Output, Emergency Start/Abort button and AUX Power.
- b) 1.5mm² or above 227 IEC 02 fire cable for Cylinder Output (Primary & Standby) and Battery connection. If the cable length is more than 50 meters, 2.5mm² or above 227 IEC 02 fire cable should be used.

2) Wiring in the loop of detector

- a) Wiring diagram when using Active End of Line unit is shown in Fig. 8.

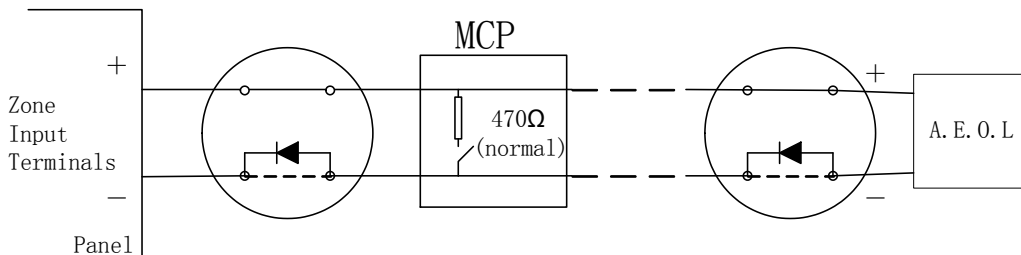

Fig. 8 Wiring diagram when using Active End of Line unit

- b) Wiring diagram when using End of Line resistor is shown in Fig. 9.

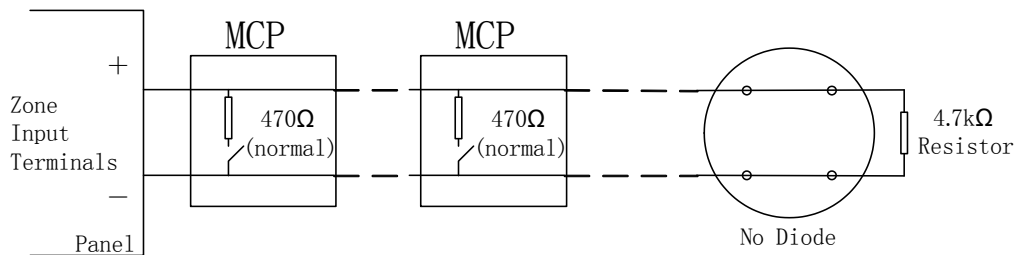
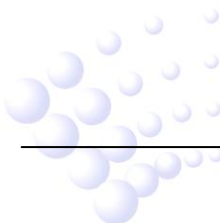

Fig. 9 Wiring diagram when using End of Line resistor

- c) Wiring method of gas override control is shown in Fig. 10.



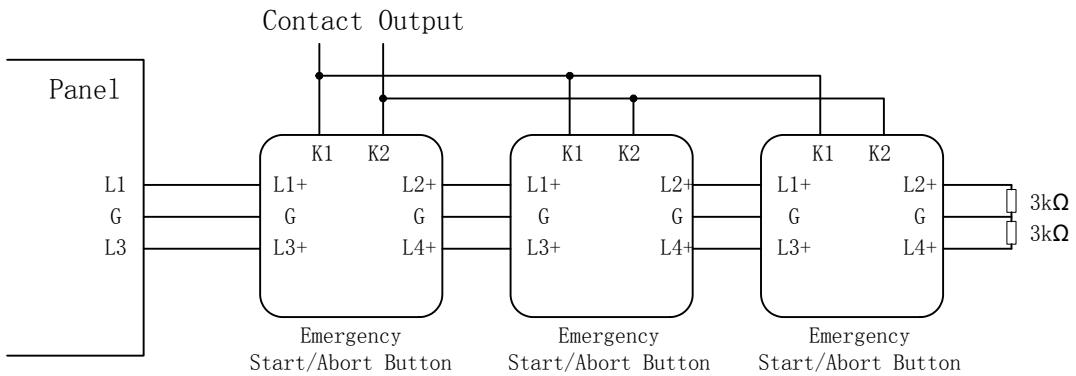

Fig. 10 Wiring method of Emergency Start/Abort Button

d) Wiring method when driving cylinder is of active output mode is shown in Fig. 11.

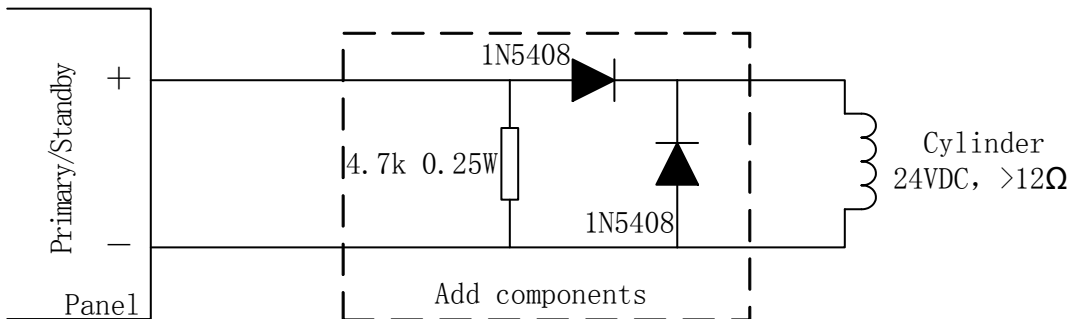

Fig. 11 Wiring method when driving cylinder is of active output mode

e) Wiring method when driving sounder is of active output mode is shown in Fig. 12.

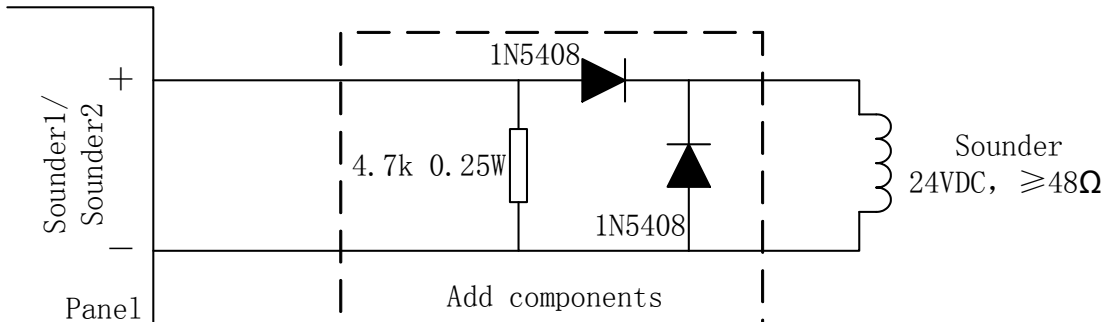
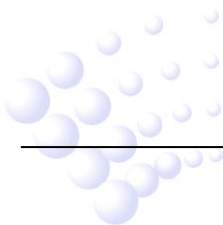

Fig. 12 Wiring method when driving sounder is of active output mode

f) All remote output are dry contact output, simple for connection with other systems.

3) Typical system connection is shown in Fig. 13.



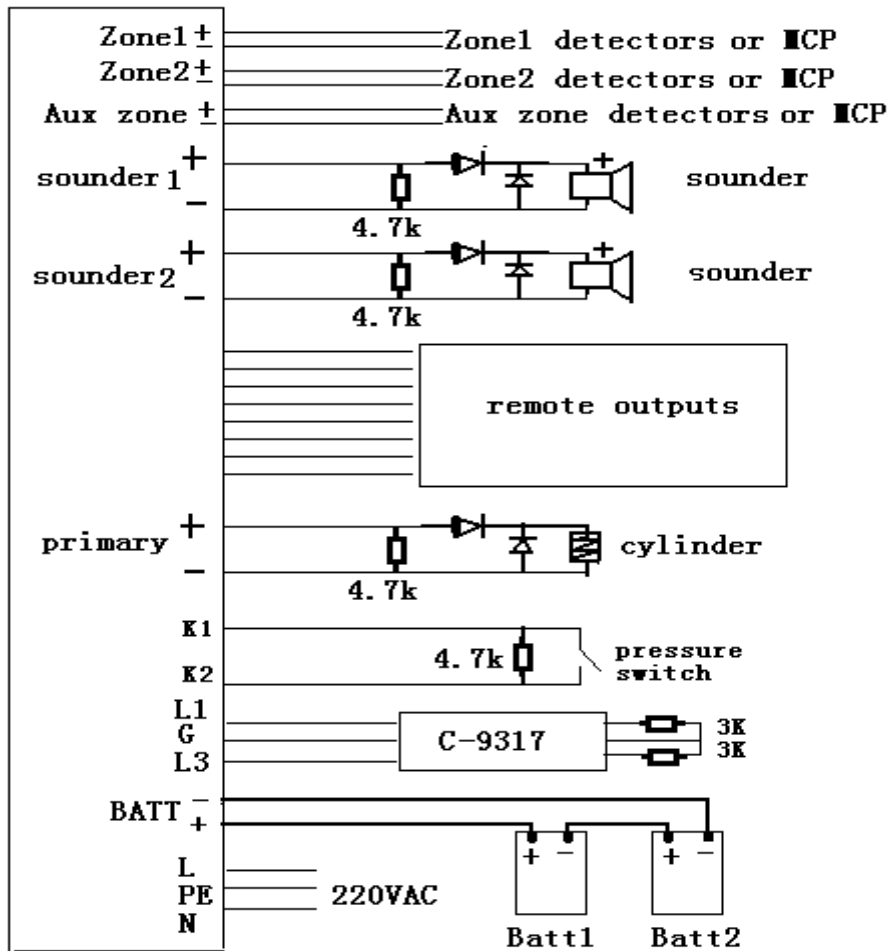

Fig. 13 Typical system connection

6 Commission

1) Configuring the outputs

Defaults of sounder outputs and gas release output are at 24VDC Active type. To meet the condition on site, these outputs can be changed to normally-open or normally-closed dry contact output. These output types can be configured through X1, X2, X3, F3, F4, F5 (on the main board).

X1 and F3 is used to set SOUNDER 1, X2 and F4 for SOUNDER 2, and X3 and F5 for gas release output. Please refer to Fig. 14 below to set X1, X2 or X3.

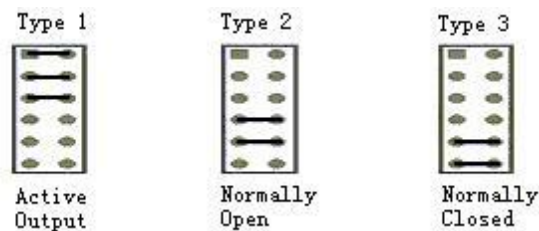

Fig. 14 Output configuration

Note: if the output type is configured to normally-open or normally-closed dry contact, the current fuse (F3, F4 or F5) must be removed.

- 2) **Configuring the Emergency Start Button**
Press the emergency start button in field can start the gas release with or without delay. Short X1 (on the display board) to set with delay and remove the jumper to set without delay. Default setting is with delay.
- 3) **Configuring the discharge output**
The discharge output can be started by pressure switch or directly by gas release output. Short X2 (on the display board) to set as using pressure switch, remove the jumper to set as not using pressure switch (active after gas release output). Default setting is using pressure switch.
- 4) **Configuring the remote output type**
The discharge, fire, fault remote output types can be changed to normally-open or normally-closed dry contact type through setting X5, X4, X6. X5 for discharge remote output. X4 for fire remote output. X6 for fault remote output. Setting method for X4, X5, and X6 is shown in Fig. 15.



Fig. 15 Remote output setting

- 5) **Setting gas release delay time**
The gas release delay time can be set from 0 to 90 seconds by adjusting S1 (on the display board). Details are shown in Table 1. Default set is 30s.

Table 1

Position of S1	0	1	2	3	4	5	6	7	8	9
Delay time	0	10	20	30	40	50	60	70	80	90

- 6) **Setting gas release output pulse duration**
The gas release output is in pulse type. The pulse duration can be set from 2 to 45 seconds by adjusting S2 (on the display board). Details are shown in the following table. Default setting is 5 seconds. See Table 2.

Table 2

Position of S2	0	1	2	3	4	5	6	7	8	9
Pulse duration	2	5	10	15	20	25	30	35	40	45

VI Operation

1 Cause and Effect

The following table shows the actions of the panel under different conditions.

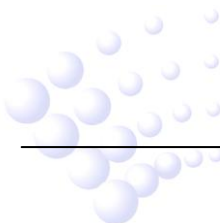

Table 3

No.	Cause	Effect
1	Zone1 alarm	<ul style="list-style-type: none"> ◆ Sounder1 start immediately ◆ Fire remote output active immediately
2	Zone2 alarm	<ul style="list-style-type: none"> ◆ Sounder1 start immediately ◆ Fire remote output active immediately
3	AUX Zone alarm	<ul style="list-style-type: none"> ◆ Sounder1 start immediately ◆ Fire remote output active immediately
4	Zone1 & Zone2 alarm	<ul style="list-style-type: none"> ◆ Sounder1 start immediately ◆ Sounder2 start immediately ◆ Fire remote output active immediately ◆ Stage 2 remote output active immediately ◆ Delay timer start immediately ◆ Gas release output start after timing finished ◆ If pressure switch is not used, start the discharge output after the release output started.
5	Emergency start button pressed	<ul style="list-style-type: none"> ◆ Sounder1 start immediately ◆ Sounder2 start immediately ◆ Fire remote output active immediately ◆ Stage 2 remote output active immediately ◆ Start the release delay timer or start the gas release output immediately (select the option by jumper when commissioning) ◆ If pressure switch is not used, start the discharge output after the release output started.
6	Start key on panel pressed	<ul style="list-style-type: none"> ◆ Sounder1 start immediately ◆ Sounder2 start immediately ◆ Fire remote output active immediately ◆ Gas start immediately without delay ◆ If pressure switch is not used, start the discharge output after the release output started.
7	Emergency Abort Switch pressed	<p>During gas delay timing</p> <ul style="list-style-type: none"> ◆ Stop Sounder2 output. ◆ Stop Timer. Show remaining time. <p>No gas delay timer</p> <ul style="list-style-type: none"> ◆ No action
8	Stop Key on panel pressed	<p>During gas delay timing</p> <ul style="list-style-type: none"> ◆ Stop Sounder2 output. ◆ Stop Timer. Show remaining time. <p>No gas delay timer</p> <ul style="list-style-type: none"> ◆ No action
9	Pressure Switch active	<ul style="list-style-type: none"> ◆ Start discharge remote output if pressure switch is used, otherwise it will not be cared.
10	Any Fault	<ul style="list-style-type: none"> ◆ Start Fault Remote output ◆ Light corresponding LED (internal fault is indicated by delay time indicator).

Note: If the gas release action has finished, the panel will not repeat automatic start or delay start. But it can be started by pressing the “START” key on the panel, the action will be kept until the pressed key released.

2 Preparation before installation and operation

- 1) Remove the two screws on the panel surface and open the front cover.
- 2) Do Wiring (referring to Clause 5 of Section 5).

Check the cables before connecting them to the panel. Ensure that there is no problem of short circuit, open circuit, earth fault and cross connection, etc.

Note: If any zone, alarm circuit, or cylinder circuit is not used, an end of line resistor must be connected to the corresponding terminal.

3) Configuration (refer to Clause 6 of Section 5)

Set the discharge/fire/fault/stage 2 remote output mode, NO or NC.

Set the sounder1/sounder2/cylinder output mode, ACTIVE, NO or NC.

Set emergency start with delay or without delay.

Set remote discharge output by pressure switch or by gas release output action.

Set delay time and output pulse duration.

4) Power Up

Connect the A.C mains to the panel and turn on the break.

Note: Do not switch on the mains supply before connecting well.

5) Battery Connection. If the panel reacts well after mains on, you can disconnect the mains and connect the batteries with correct polarity.

3 Manual Operations

1) Starting gas release from the panel

Press the "START" key on the panel will start the gas release output without any delay. This operation is controlled under "Control Enable" switch (by key).

2) Starting gas release in field

Press the Emergency Start button on field will start the gas release output with or without delay (configurable). This function is not inhibited by "Auto Enable" setting.

3) Stopping gas release from the panel

During the gas release delay timing, press the "STOP" key will stop the timer. The output terminal will be electronically isolated. This function is not inhibited by "Auto Enable" and "CONTROL ENABLE" setting. **Note: if the timer is finished and the panel is starting the gas release action, the stop operation will not function.**

4) Stopping gas release in field

During the gas release delay time, press the emergency abort switch will stop the timer. The output terminal will be electronically isolated. This function is not inhibited by "Auto Enable" and "Control Enable" setting. **Note: if the timer is finished and the panel is starting the gas release action, the stop operation will not function.**

5) Silencing the sounders & alarming panel

Press "Silence" key to stop sounder outputs and the buzzer of the panel. This operation is controlled under "Control Enable" switch. **Note: if the "Evacuate" key is active, the "Silence" key will not act.** (If it's within gas release delay time, pressing "Silence" will not stop the panel alarming. The sounder outputs will be resumed in the last 15 seconds.) .

6) Starting the sounders

Press “Evacuate” key to start the sounder outputs. This operation is controlled by “Control Enable” switch.

7) Isolation/De-isolation operation

In case of false-alarm and fault, if the problem cannot be removed immediately, the faulty zone can be logically isolated in order to avoid false-release and noises. After the problem is solved, De-isolate to resume the functions. The Isolation/De-isolation operation is available for Zone1, Zone2, AUX Zone and the Cylinder. Pressing the corresponding “ISO1~ISO4” key to change the isolation condition. This operation is controlled by “Control Enable” switch.

8) Standby cylinder output

To ensure fire protection, there should be 2 sets of gas cylinders in field. In case of fault with the primary (discharge, low pressure or other problems), switch the output to standby terminal. **Note: Only the circuit in use is monitored.**

VII Troubleshooting

The panel itself is able to check and judge fault. If there is any short or broken circuit with wiring of a certain zone, the panel will light corresponding fault indicator, and output fault remote signal. If it still cannot work normally or still alarm fault, please contact GST technical support personnel.

VIII Cautions

- **If the cylinder’s output or the sounder’s output is set as a normally-open or normally-closed type, the corresponding current fuse must be removed!**
- **‘ISO4’ operation is only valid for gas release actions caused by emergency start button and detection zones. The “START” key on the panel is not under control. That means even if the output is isolated, gas release can still be active by the “START” key. So, only when “ISO4” is active and “Control Enable” is Off, will gas release output be completely inhibited.**
- **If there is any serious internal error during self-test, the panel will show flashing ‘E0’ on its front panel and start the fault remote output. In this case, repair must be done.**
- **The panel must be properly grounded to ensure safety.**
- **The panel must be maintained or repaired by authorized and skilled person.**

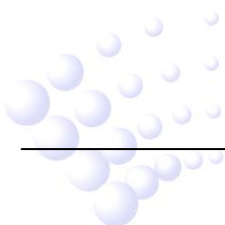



Gulf Security Technology Co., Ltd.

No. 80, Changjiang East Road, QETDZ, Qinhuangdao, Hebei,

P. R. China 066004

Tel: +86 (0) 335 8502434

Fax: +86 (0) 335 8502532

service.gst@fs.utc.com

www.gst.com.cn